

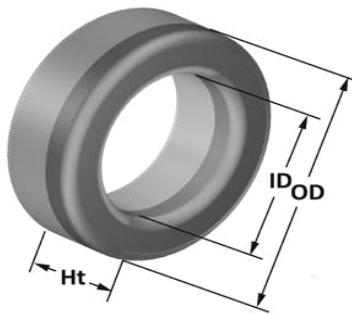

ST102-275B
Composite (Iron Powder / Ferrite) Core



Dimensions:	in.	mm.
OD:	1.025 +/- 0.030 (1.055 / 0.995)	26.04 +/- 0.76 (26.80 / 25.27)
ID:	0.600 +/- 0.020 (0.620 / 0.580)	15.24 +/- 0.51 (15.75 / 14.73)
HT:	0.625 +/- 0.025 (0.650 / 0.600)	15.88 +/- 0.64 (16.51 / 15.24)

Magnetic Dimensions:

Ae:	0.814 cm ²
Le:	6.48 cm
Ve:	5.28 cm ³

Basic Material Characteristics:

Material Type:	25% Ferrite, 75% Mix-52
μ_i (reference)	2300 (Ferrite), 75 (Mix-52)
Temp Stability:	N/A
Color Code:	Green
Finish:	Per UL Card File #E140098(S)

Inductance:

AL:	825 +35%/-25% (1114 / 619)
Test Winding:	50 Turns, AWG-24, single-evenly spaced layer, tightly wound, 1/2" leads
Test Instrument:	HP4274A
Test Frequency:	10 kHz
Test Voltage:	0.18V (Bpk=10gauss)

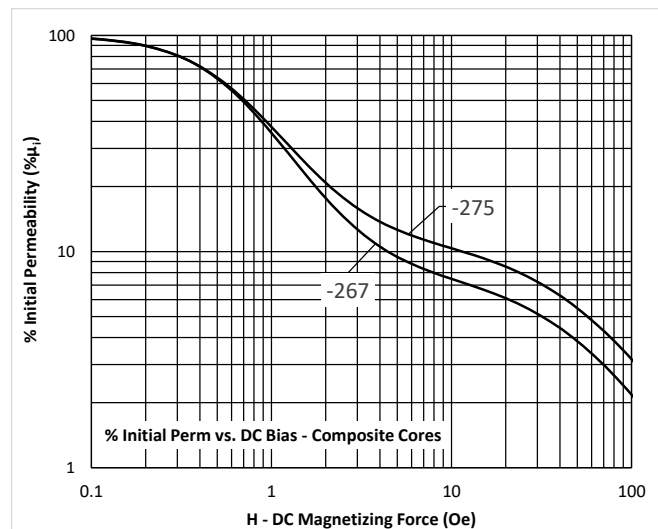

Note: The ferrite core material is temperature sensitive and the inductance will increase as the temperature increases. Minimize handling of the wound core during test. Maintain part at +25C for testing. A small gap or parting line between the cores is normal and acceptable, not a cause for rejection. The Thermal Aging Properties on Micrometals Mix -52 are unique to Micrometals alone and not our competitors. Micrometals Color codes are protected by US Patent and Trade Mark Law. Micrometals Iron Powder Cores comply with the EU Directives 2002/95/EC and 2003/11/EC. Any possible unintentional RoHS trace elements are less than 100 ppm.