

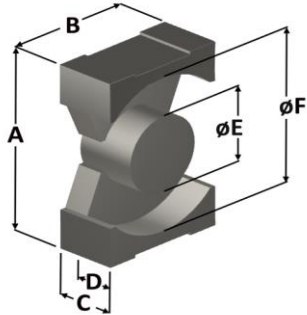

Part Number: PQHF-213140081-040
 Revision 20200820 - Generated 2020-Aug-20

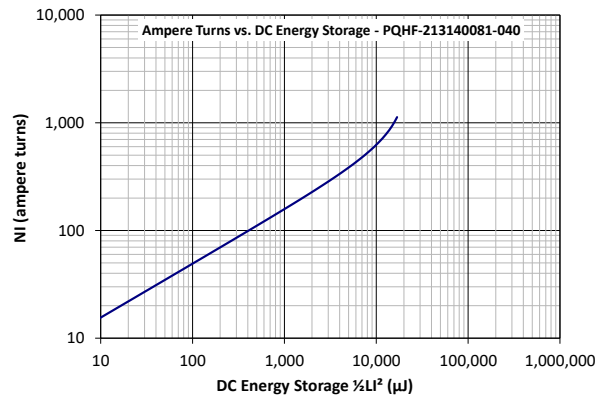

A	21.3 ± 0.41 mm	0.839 ± 0.016 in											
B	14 ± 0.41 mm	0.551 ± 0.016 in											
C	8.1 ± 0.20 mm	0.319 ± 0.008 in											
D	5 mm (min.)	0.197 in (min.)											
E	8.8 ± 0.41 mm	0.346 ± 0.016 in											
F	17.6 mm (min.)	0.693 in (min.)											
Mass	(approximate)	7.8 grams/half											
Magnetic Dimensions	A _e - Eff. Mag. Cross Section	0.619 cm ²											
	L _e - Eff. Mag. Path Length	3.76 cm											
	V _e - Eff. Core Volume	2.33 cm ³											
	WA - Min. Eff. Window Area	0.420 cm ²											
	sa - Surface Area	16.7 cm ²											
	mlt - mean length per turn	4.15 cm											
Inductance	μ _i (reference)	40											
	A _i value (nominal)	83 nH/N ²											
	Test Winding	N=10, #20 AWG											
	Frequency	10 kHz											
	Voltage on Agilent 4284A	0.027 V											
A _i tolerance	±12%												
Core Loss	$\text{Core Loss (mW/cm}^3\text{)} = \frac{f}{B_{pk}^3} + \frac{b}{B_{pk}^{2.3}} + \frac{c}{B_{pk}^{1.65}} + d \cdot B_{pk}^2 \cdot f^2$												
	where B _{pk} expressed in gauss, f expressed in hertz, and: a=1.00E+06, b=3.59E+08, c=3.25E+06, d=2.14E-14												
	B _{pk}	1000 G											
	frequency	50 kHz											
	Core Loss (nominal)	666 mW/cm ³											
Core Loss (maximum)	766 mW/cm ³												
DC Saturation	$\% \mu_i = \frac{1}{a + b \cdot H^c} + d$												
	where H expressed in oersteds, and: a=0.01, b=8.45E-08, c=2.10, d=0.00												
	H _{dc}	100 Oe											
	Percent Initial Perm(nom.)	88.4%											
Percent Initial Perm(min.)	83.8%												
Coating/Pkg	Coating Type:	None											
	Voltage Breakdown (min.)	N/A											
	Limit	N/A											
	Package Quantity	1,309 Halves/Box											
Winding Table	Wire Size	AWG	16	18	20	22	24	26	28	30	32	34	36
		mm	1.250	1.000	0.800	0.630	0.500	0.400	0.315	0.250	0.200	0.160	0.125
	Full Winding	Turns	13	20	31	48	75	115	178	276	428	662	1,024
		Rdc(Ω)	7.1 m	17.4 m	42.8 m	105.3 m	261.7 m	638.3 m	1.6	3.9	9.6	23.5	57.8

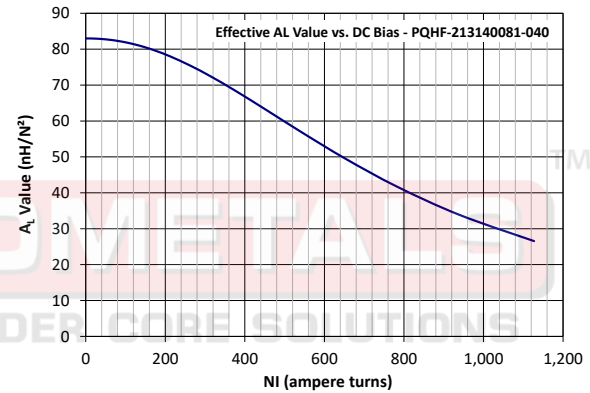
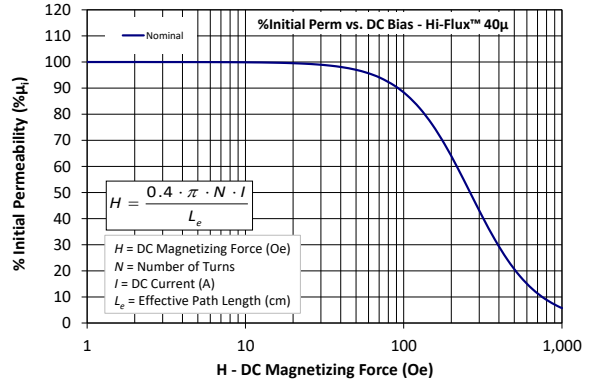
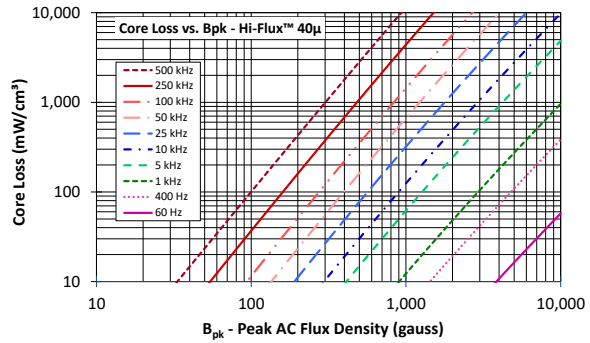

Handling and Storage: Cores should be stored in the original unopened packaging between -10°C and +50°C and less than 60% relative humidity. After the original packaging is opened, the cores should be stored between -8°C and +25°C less than 30% relative humidity. Gloves should be used when handling uncoated cores. The cores should also be sheltered from rain, moisture, salt water, salt air, plasters, ashes, sulfur, sulfur dioxide, ammonia sulfates, soils, acids, metals shavings, and solvents.

Operating Temperature: Cores can be used continuously at operating temperatures between -60°C and +200°C.

RoHS 2.0, REACH and ISO (TS16949, ISO 9001, ISO 14001) compliant. Statements available for download at www.micrometalsapc.com.