

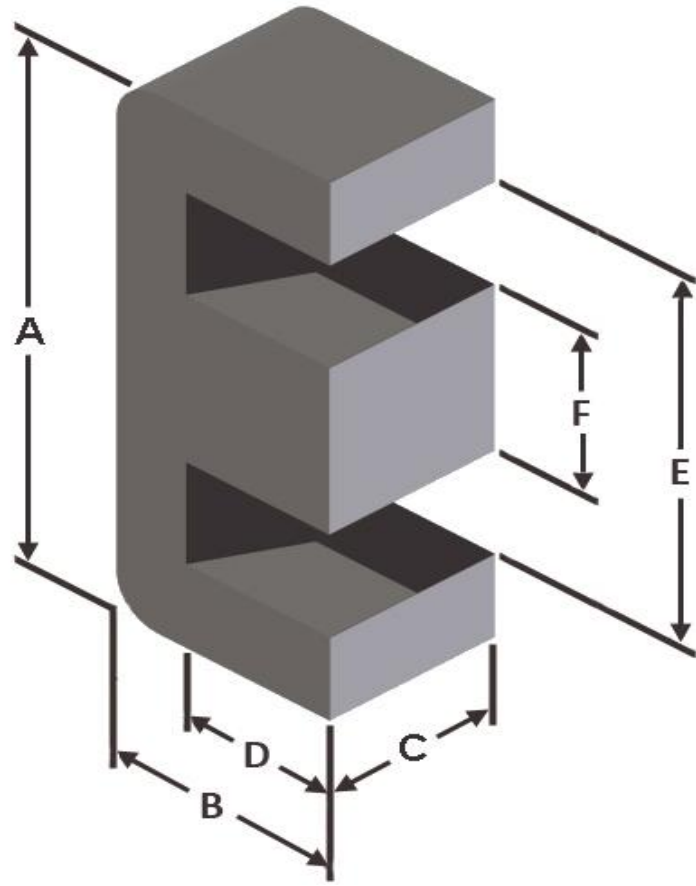

Part Number: EMS-0130604-026

Revision 20190529 - Generated 2019-May-29



A	12.7 ± 0.25 mm	0.500 ± 0.010 in
B	6.4 ± 0.10 mm	0.252 ± 0.004 in
C	3.56 ± 0.15 mm	0.140 ± 0.006 in
D	4.42 mm (min.)	0.174 in (min.)
E	8.89 mm (min.)	0.350 in (min.)
F	3.56 ± 0.13 mm	0.140 ± 0.005 in
Mass	(approximate)	0.94 grams/half
Magnetic Dimensions	A _e - Eff. Mag. Cross Section	0.130 cm ²
	L _e - Eff. Mag. Path Length	2.96 cm
	V _e - Eff. Core Volume	0.385 cm ³
	WA - Min. Eff. Window Area	0.230 cm ²
	sa - Surface Area	6.01 cm ²
	mlt - mean length per turn	2.49 cm
Inductance	μ _i (reference)	26
	A _L value (nominal)	20 nH/N ²
	Test Winding	N=100, #28 AWG
	Frequency	10 kHz
	Voltage on Agilent 4284A	0.058 V
	A _L tolerance	±8%
Core Loss	$\text{Core Loss (mW/cm}^3\text{)} = \frac{f}{\frac{a}{B_{pk}^3} + \frac{b}{B_{pk}^{2.3}} + \frac{c}{B_{pk}^{1.65}}} + d \cdot B_{pk}^2 \cdot f^2$	
	where B _{pk} expressed in gauss, f expressed in hertz, and: a=1.00E+06, b=4.97E+08, c=3.99E+06, d=2.87E-14	
	B _{pk}	500 G
	frequency	100 kHz
	Core Loss (nominal)	295 mW/cm ³
Core Loss (maximum)	339 mW/cm ³	
DC Saturation	$\% \mu_i = \frac{1}{a + b \cdot H^c} + d$	
	where H expressed in oersteds, and: a=0.01, b=1.53E-06, c=1.65, d=0.00	
	H _{DC}	200 Oe
	Percent Initial Perm(nom.)	50.5%
Percent Initial Perm(min.)	43.0%	
Coating/Pkg	Coating Type:	None
	Voltage Breakdown (min.)	N/A
	Limit	N/A
	Package Quantity	1,500 Halves/Box

Winding Table	Wire Size	AWG	20	22	24	26	28	30	32	34	36	38	40
		mm	0.800	0.630	0.500	0.400	0.315	0.250	0.200	0.160	0.125	0.100	0.080
	Full Winding	Turns	17	26	41	63	98	151	234	363	561	869	1,345
		Rdc(Ω)	14.1 m	34.3 m	85.9 m	209.9 m	519.4 m	1.3	3.1	7.7	19.0	46.9	115.3

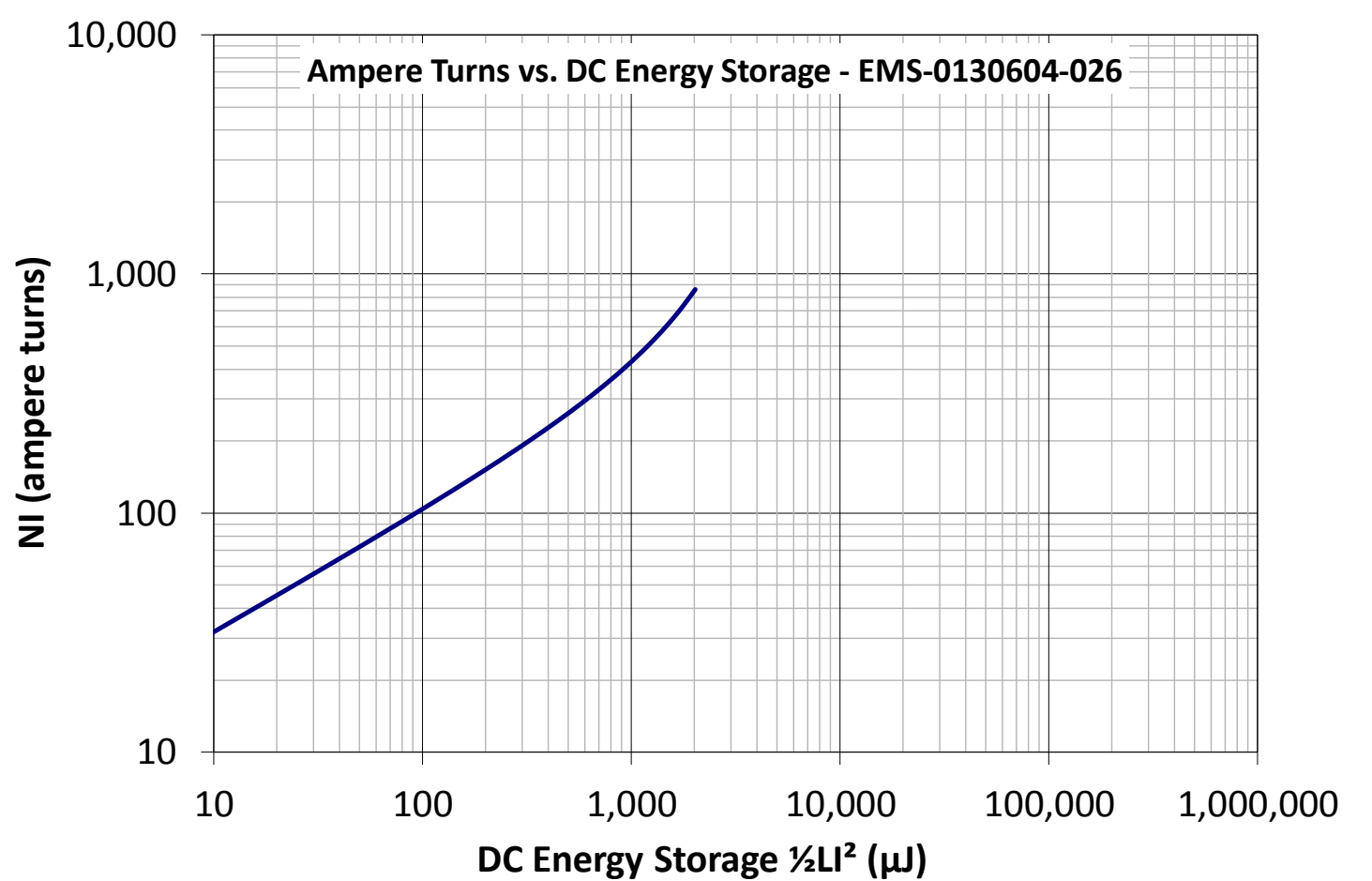
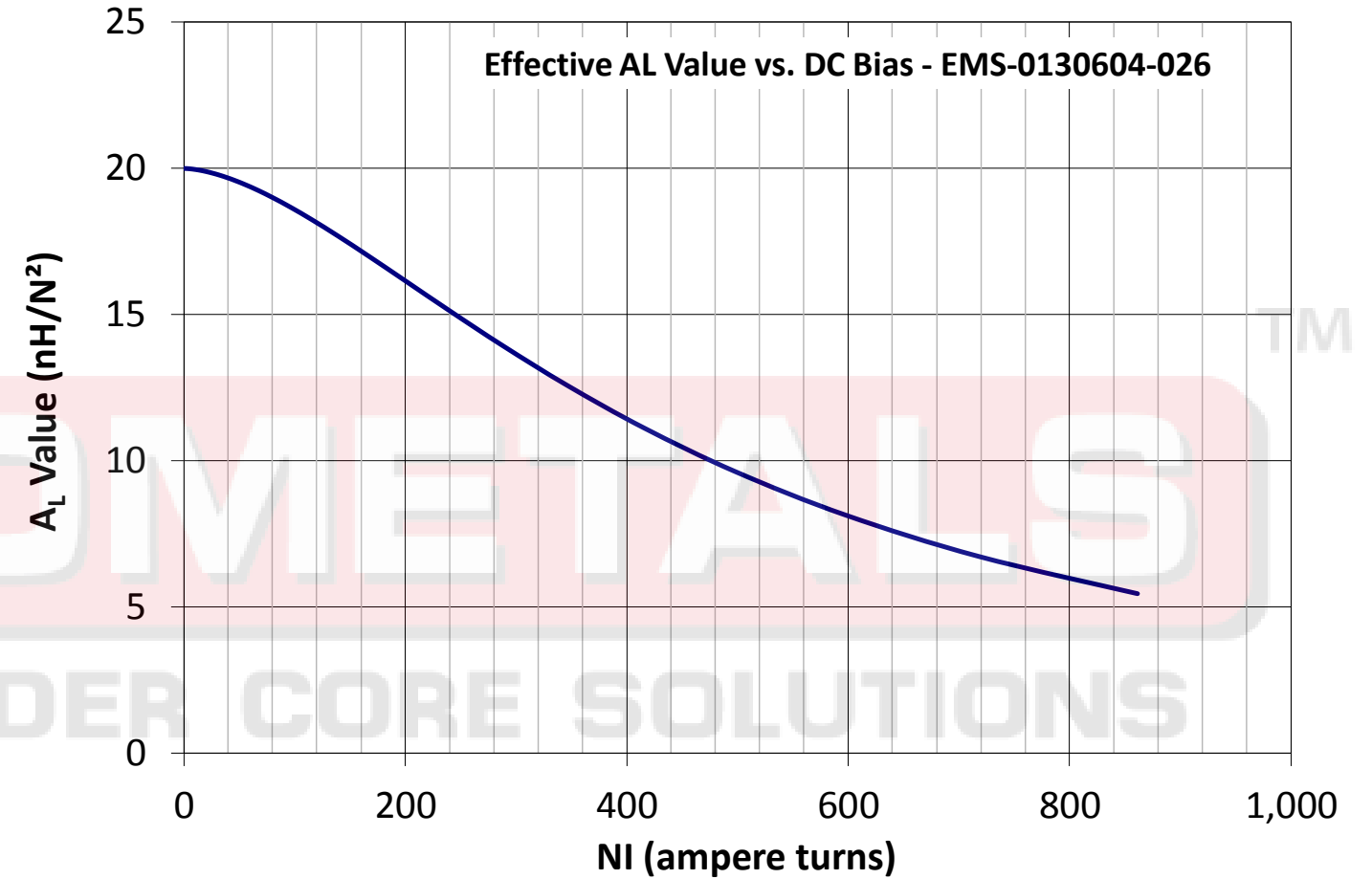
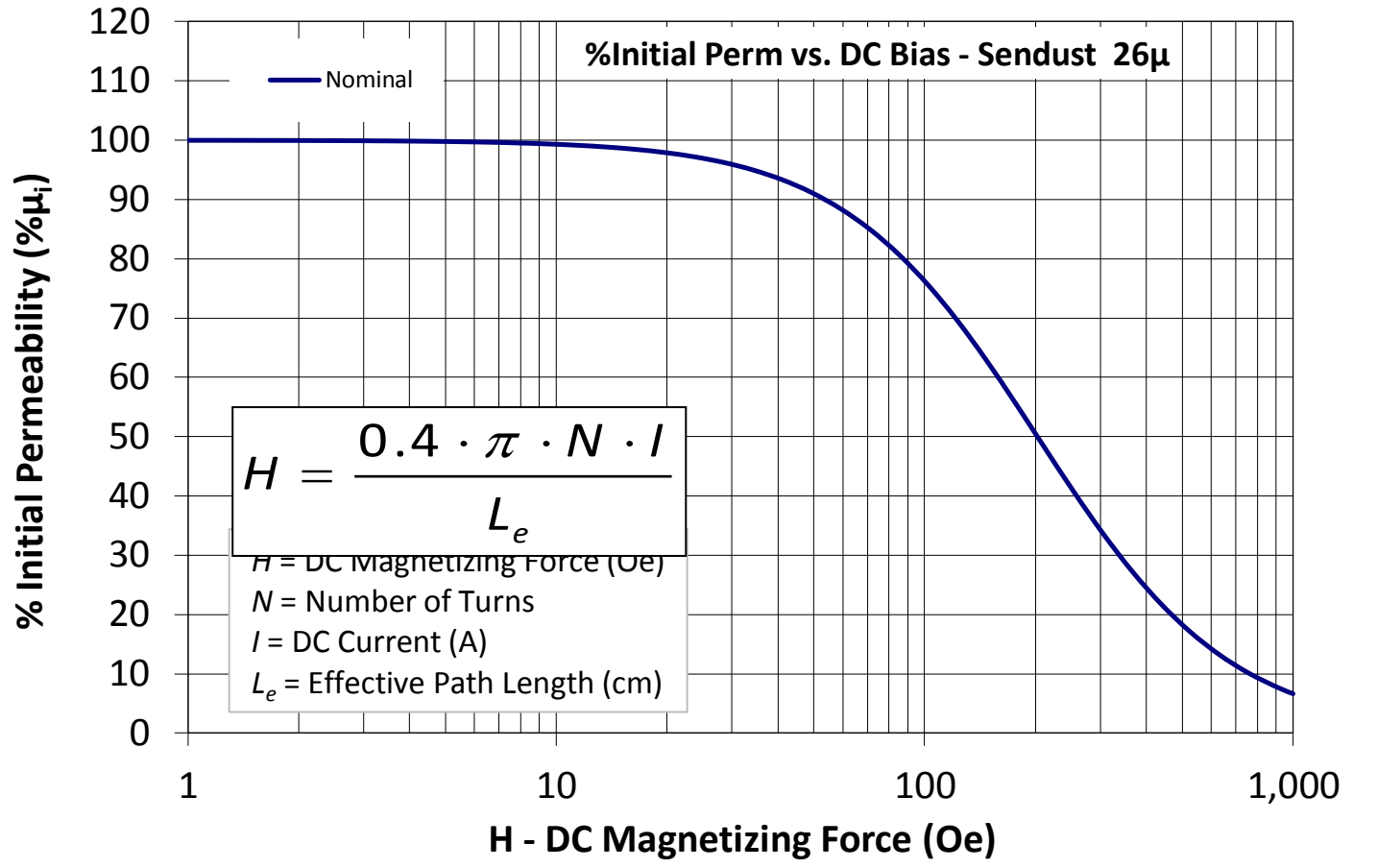
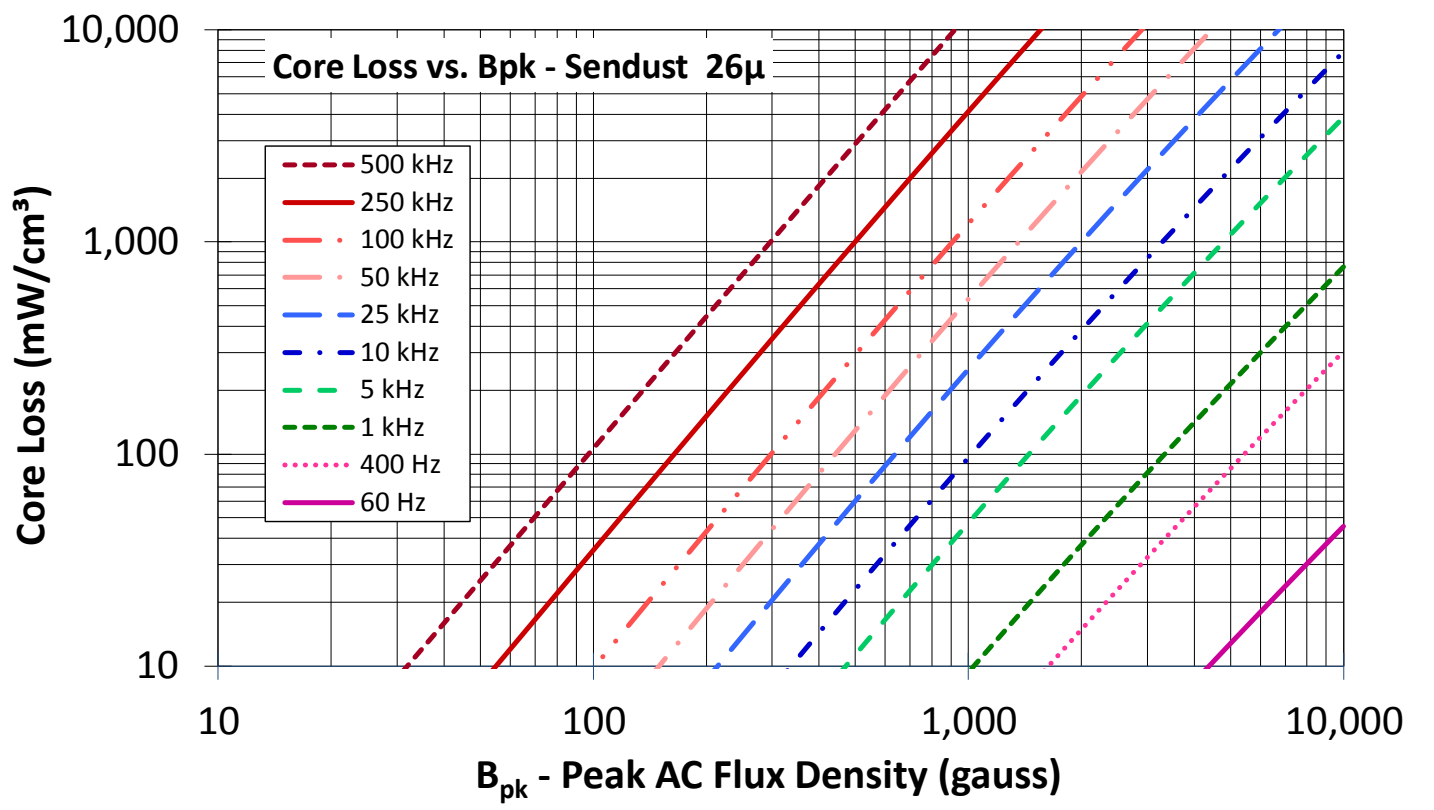

Handling and Storage: Cores should be stored in the original unopened packaging between -10°C and +50°C and less than 60% relative humidity. After the original packaging is opened, the cores should be stored between -8°C and +25°C less than 30% relative humidity. Gloves should be used when handling uncoated cores. The cores should also be sheltered from rain, moisture, salt water, salt air, plasters, ashes, sulfur, sulfur dioxide, ammonia sulfates, soils, acids, metals shavings, and solvents.

Operating Temperature: Cores can be used continuously at operating temperatures between -60°C and +200°C.

RoHS 2.0, REACH and ISO (TS16949, ISO 9001, ISO 14001) compliant. Statements available for download at www.micrometalsapc.com.

Micrometals Alloy Powder Cores, A Division of Micrometals, Inc. - 5615 E. La Palma Ave., Anaheim, California 92807 USA

Ph: +1-714-970-9400, Toll Free in USA: +1-800-356-5977, Asia Pacific Sales: +852 3106 3736

www.MicrometalsAPC.com