

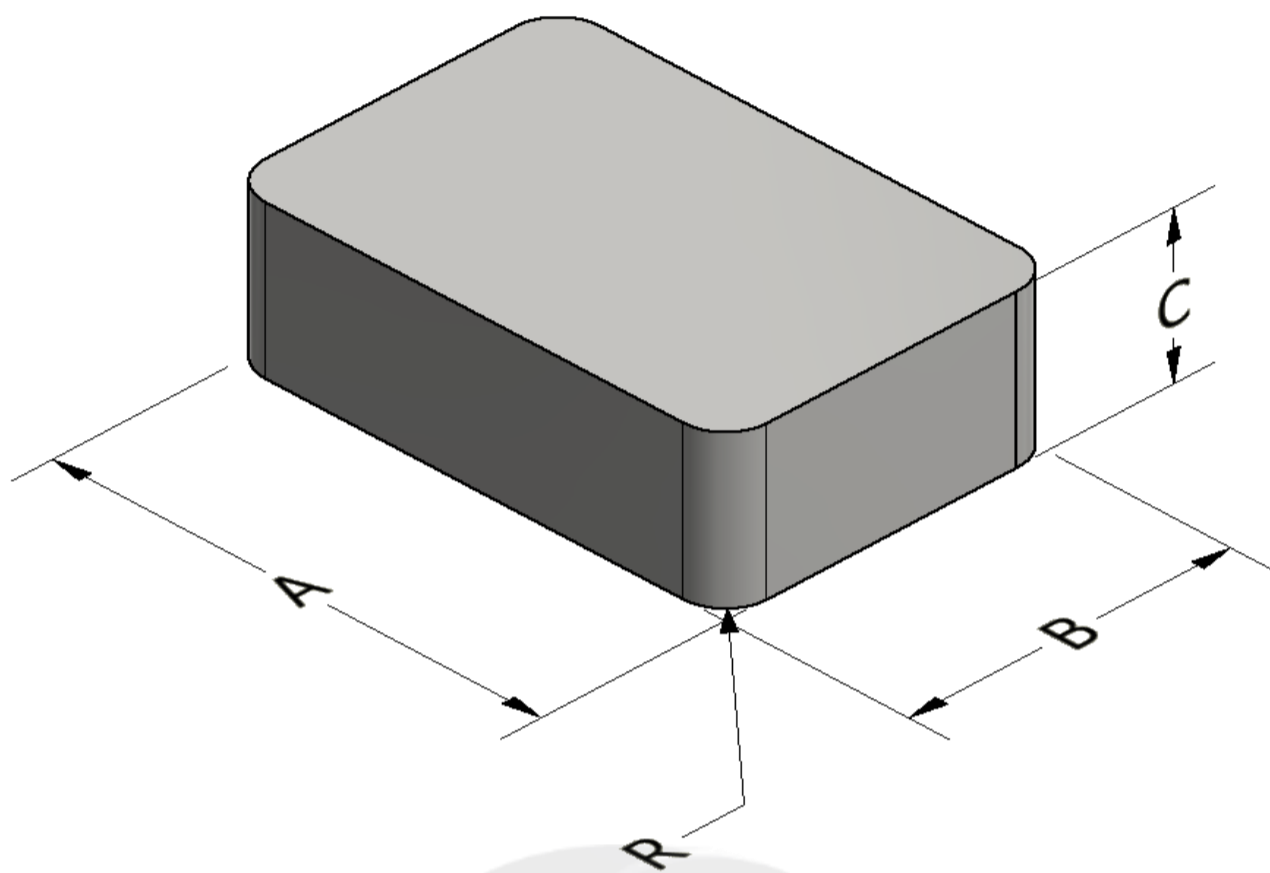

Part Number: **BFS-0503010-026**

Revision 20190529 - Generated 2019-May-29



A	50.00 ± 0.50 mm	1.969 ± 0.020 in
B	30.00 ± 0.50 mm	1.181 ± 0.020 in
C	10.00 ± 0.50 mm	0.394 ± 0.020 in
R	1.5 ± 0.50 mm	0.059 ± 0.020 in
	μ_i (reference)	26
Mass	(approximate)	90 grams
Core Loss	$\text{Core Loss (mW/cm}^3\text{)} = \frac{f}{\frac{a}{Bpk^3} + \frac{b}{Bpk^{2.3}} + \frac{c}{Bpk^{1.65}}} + d \cdot Bpk^2 \cdot f^2$	
	where B_{pk} expressed in gauss, f expressed in hertz, and: $a=1.00E+06$, $b=1.70E+08$, $c=3.12E+06$, $d=6.33E-14$	
	B_{pk}	300 G
	frequency	100 kHz
	Core Loss (nominal)	225 mW/cm ³
Core Loss (maximum)	258 mW/cm ³	
DC Saturation	$\% \mu_i = \frac{1}{a + b \cdot H^c} + d$	
	where H expressed in oersteds, and: $a=0.01$, $b=8.58E-07$, $c=1.58$, $d=0.00$	
	H_{DC}	200 Oe
	Percent Initial Perm(nom.)	72.8%
Percent Initial Perm(min.)	66.7%	
Coating/Pkg	Coating Type:	None
	Voltage Breakdown (min.)	N/A
	Limit	N/A
	Package Quantity	140 Pieces/Box

