

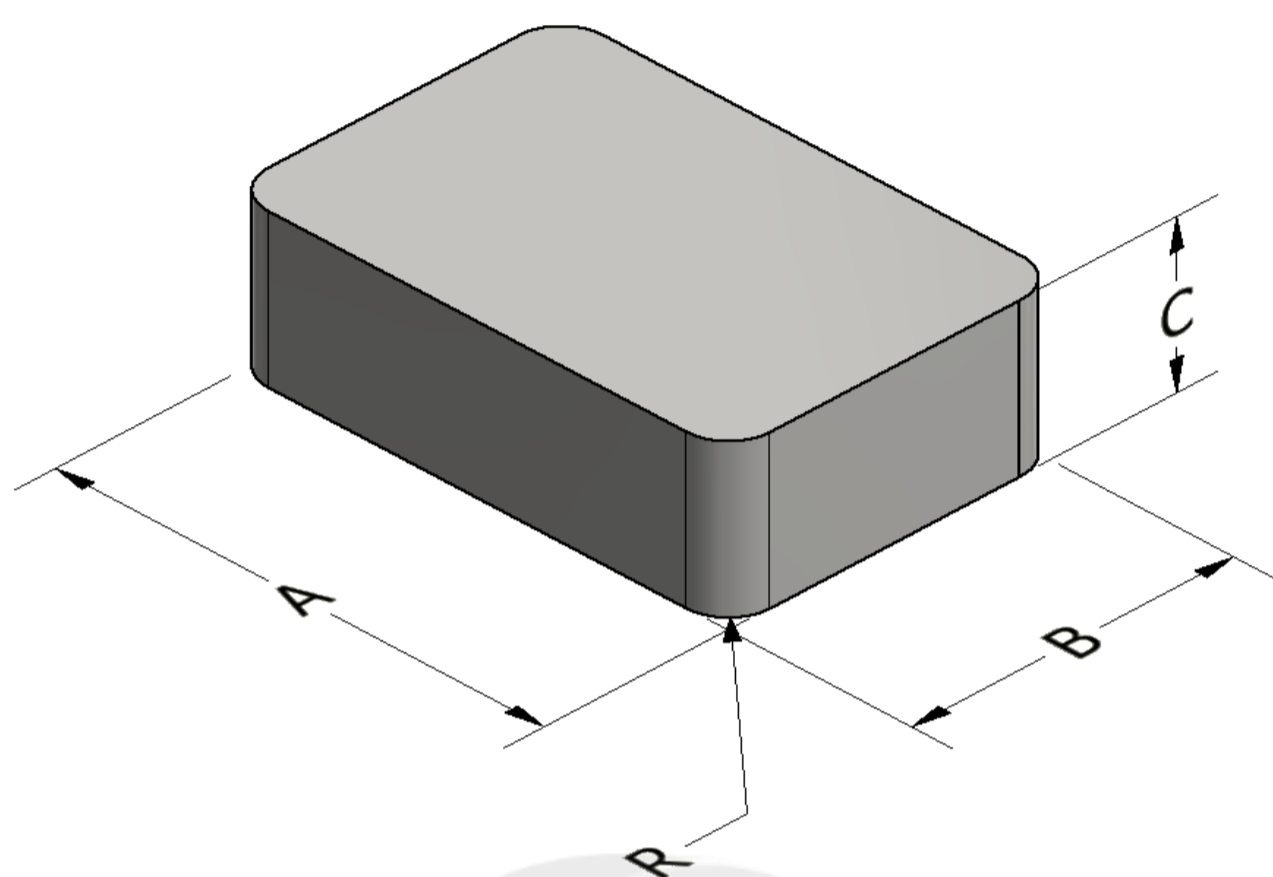

Part Number: **BFS-0474128-040**

Revision 20190529 - Generated 2019-May-29



A	47.50 ± 0.50 mm	1.870 ± 0.020 in
B	41.00 ± 0.50 mm	1.614 ± 0.020 in
C	27.50 ± 0.50 mm	1.083 ± 0.020 in
R	1.5 ± 0.50 mm	0.059 ± 0.020 in
	μ_i (reference)	40
Mass	(approximate)	340 grams
Core Loss	$\text{Core Loss (mW/cm}^3\text{)} = \frac{f}{\frac{a}{Bpk^3} + \frac{b}{Bpk^{2.3}} + \frac{c}{Bpk^{1.65}}} + d \cdot Bpk^2 \cdot f^2$	
	where B_{pk} expressed in gauss, f expressed in hertz, and: $a=1.00E+06$, $b=2.70E+08$, $c=3.23E+06$, $d=7.09E-14$	
	B_{pk}	1000 G
	frequency	50 kHz
	Core Loss (nominal)	889 mW/cm ³
Core Loss (maximum)	1,022 mW/cm ³	
DC Saturation	$\% \mu_i = \frac{1}{a + b \cdot H^c} + d$	
	where H expressed in oersteds, and: $a=0.01$, $b=1.53E-06$, $c=1.62$, $d=0.00$	
	H_{DC}	100 Oe
	Percent Initial Perm(nom.)	79.0%
Percent Initial Perm(min.)	73.7%	
Coating/Pkg	Coating Type:	None
	Voltage Breakdown (min.)	N/A
	Limit	N/A
	Package Quantity	60 Pieces/Box

